

SPECIFICATION

Customer : QUARTZ

受 控

Applied To :

Product Name : Piezo Buzzer

Model Name : KPI-G2210L-06-K9891



Drawing No. : OEM9891R

Compliance with ROHS(本品符合ROHS指令)

Signature of Approval

--

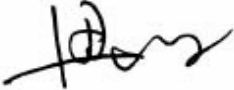
Signature of KEPO

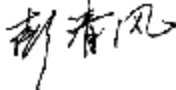
Approved by	Checked by	Issued by	Date
			

宁波凯普电子有限公司



Ningbo Kepo Electronics Co.,Ltd.

宁波东钱湖镇东钱湖工业区宝源路 25 号

TEL:+86-574-88370330 FAX:+86-574-88370329

No.25 Baoyuan road Dongqian Lake, Industry Area, Dongqian town, Ningbo City, China(Post Code:315121)

Sales@chinaacoustic.com

www.chinaacoustic.com

Specification for Buzzer	Page	2/8
	Revision No.	1.0
	Drawing No.	OEM9891R
Model No. : KPI-G2210L-06-K9891		

CONTENTS

1. Scope
范围
2. General
概要
3. Maximum Rating
额定极限条件
4. Electrical Characteristics
电性能
5. Measuring Method
测试方法
6. Physical Characteristics
机械性能
7. Environmental Characteristics
环境性能
8. Dimensions
尺寸
9. Packaging Standard
包装标准
10. Cautions
警告
11. Cautions for Use
注意事项
12. Revision
履历表

Specification for Buzzer	Page	3/8
	Revision No.	1.0
	Drawing No.	OEM9891R

Model No. : KPI-G2210L-06-K9891

1. 范围 Scope

This product specification is applied to the piezoelectric sounder in alarm systems. Please contact us when using this product for any other applications than described in the above.

本规格书适用于压电式蜂鸣器，通常它用在系统中做报警或提示的蜂鸣器用，如果将该产品用于其它领域，请与我们联系。

2. 概要 General

2.1 Out-Diameter : Ø22mm

外径: Ø22 mm

2.2 Height : 10.5mm

高度: 10.5 mm

2.3 Weight : 6 gr.

重量: 6克

2.4 Case Material : ABS

壳体材质: ABS

3. 额定极限条件 Maximum Rating

	项目 Item	规格 Specification
3.1	最高输入电压 Maximum input Voltage	4-8VDC
3.2	工作温度范围 Operating Temperature Range	-20 ~ +60°C
3.3	储存温度范围 Storage Temperature Range	-30 ~ +70°C

4. 电性能 Electrical Characteristics

	项目 Item	规格 Specification
4.1	声压 Sound Pressure Level	85dB at 6VDC/30cm
4.2	频率 Resonant Frequency	4.8± 0.5KHz
4.3	电流 Max.Rated Current	15mA at 6VDC
4.4	音调 Tone Nature	Continuous

测试条件参见下项

Refer to next item for measuring method.

Specification for Buzzer	Page	4/8
	Revision No.	1.0
	Drawing No.	OEM9891R

Model No. : KPI-G2210L-06-K9891

5. 测试方法 Measuring Method

5.1 声压测试线路 S.P.L. Measuring Circuit

输入信号:6VDC
Input Signal:6VDC

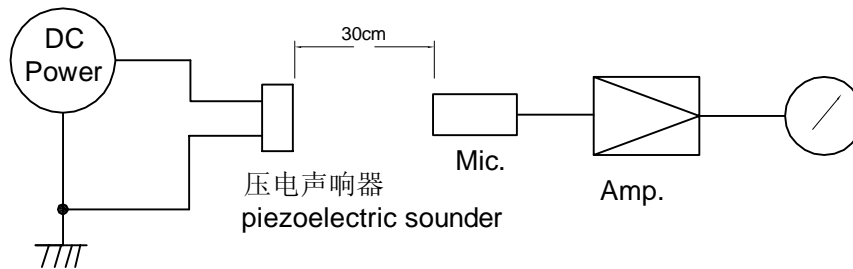

MIC : ND10 普通声级计或等同品
MIC : ND10 Sound Meter or equivalent

稳压电源 : DF1730SL2A 或等同品
DC Power Supply : DF1730SL2A or equivalent

5.2 测试环境 Measuring Condition

温度 $+25\pm 3^{\circ}\text{C}$, 湿度 $60\pm 10\%\text{R.H.}$.标准测试状态,在没有疑问的场合,可以在温度 $+5\sim +35^{\circ}\text{C}$,湿度 $45\sim 85\%\text{R.H.}$ 的范围内测试.

Part shall be measured under a condition (Temperature : $+5$ to $+35^{\circ}\text{C}$, Humidity : 45 to $85\%\text{R.H.}$) unless the standard condition (Temperature : $+25 \pm 3^{\circ}\text{C}$, Humidity : $60 \pm 10\%\text{R.H.}$) is regulated measure.

6. 机械性能 Physical Characteristics

	实验项目 Item	实验条件 Test Condition	实验后规格 Specification
6.1	耐冲击性 Shock	峰值加速度 490m/s^2 , 半正弦波, XYZ三个方向各3次冲击实验后, 测试声响器. Sounder shall be measured after being applied shock(490m/s^2) for each three mutually perpendicular directions to each of 3 times by half sine wave.	符合表1的要求 The measured value shall meet Table 1.
6.2	耐振动性 Vibration Resistant	振动频率 $10\sim 55\text{ Hz}$, 1.5mm 全振幅, XYZ三个方向各2小时试验后, 测试声响器. Sounder shall be measured after being applied vibration of amplitude of 1.5mm with 10 to 55Hz band of vibration frequency to each of 3 perpendicular directions for 2 hours.	
6.3	抗跌落性 Dropping	75cm 高度/2回自然落到亚麻布垫上. Dropped from 75cm high to linen with 2 times.	

Specification for Buzzer	Page	5/8
	Revision No.	1.0
	Drawing No.	OEM9891R

Model No. : KPI-G2210L-06-K9891

7. 环境性能 Environmental Characteristics

	实验项目 Item	实验条件 Test Condition	实验后规格 Specification
7.1	高温放置 Dry Heat Test (Storage)	<p>放置于温度$+70 \pm 2^\circ\text{C}$的烘箱内240小时, 然后取出, 在常温下放置4小时后, 测试声响器。</p> <p>After being placed in a chamber with $+70 \pm 2^\circ\text{C}$ for 240 hours and then being placed in natural condition for 4 hours, sounder shall be measured.</p>	符合表1的要求 The measured value shall meet Table 1.
7.2	低温放置 Cold Test (Storage)	<p>放置于温度$-30 \pm 2^\circ\text{C}$的制冷箱内240小时, 然后取出, 在常温下放置4小时后, 测试声响器。</p> <p>After being placed in a chamber with $-30 \pm 2^\circ\text{C}$ for 240 hours and then being placed in natural condition for 4 hours, sounder shall be measured.</p>	
7.3	耐湿性 Humidity	<p>放置于90%~95% R.H., 温度$+40 \pm 2^\circ\text{C}$的环境试验箱内240小时, 然后取出, 在常温下放置4小时后, 测试声响器。</p> <p>After being placed in a chamber with 90 to 95% R.H. at $+40 \pm 2^\circ\text{C}$ for 240 hours and then being placed in natural condition for 4 hours, sounder shall be measured.</p>	
7.4	温度循环 Temperature Cycle	<p>先放置于温度$-30 \pm 2^\circ\text{C}$的制冷箱内30分钟, 然后放置于室温($+20^\circ\text{C}$)15分钟后, 放置于$+70 \pm 2^\circ\text{C}$的烘箱内30分钟, 再放置于室温($+20^\circ\text{C}$)15分钟。 经过以上循环5次, 在常温下放置4小时后, 测试声响器。</p> <p>After being placed in a chamber at $-30 \pm 2^\circ\text{C}$ for 30 minutes, sounder shall be placed at room temperature ($+20^\circ\text{C}$). After 15 minutes at this temperature, sounder shall be placed in a chamber at $+70 \pm 2^\circ\text{C}$. After 30 minutes at this temperature, sounder shall be returned to room temperature ($+20^\circ\text{C}$) for 15 minutes. After 5 above cycles, sounder shall be measured after being placed in natural condition for 4 hours.</p>	

表 1 Table 1

项 目 Item	试验后变化量 Specification after test
声压级 Sound Pressure Level	初始值 $\pm 10\text{dB}$ Initial Value $\pm 10\text{dB}$

Specification for Buzzer	Page	6/8
	Revision No.	1.0
Model No. : KPI-G2210L-06-K9891	Drawing No.	OEM9891R

8. Dimensions

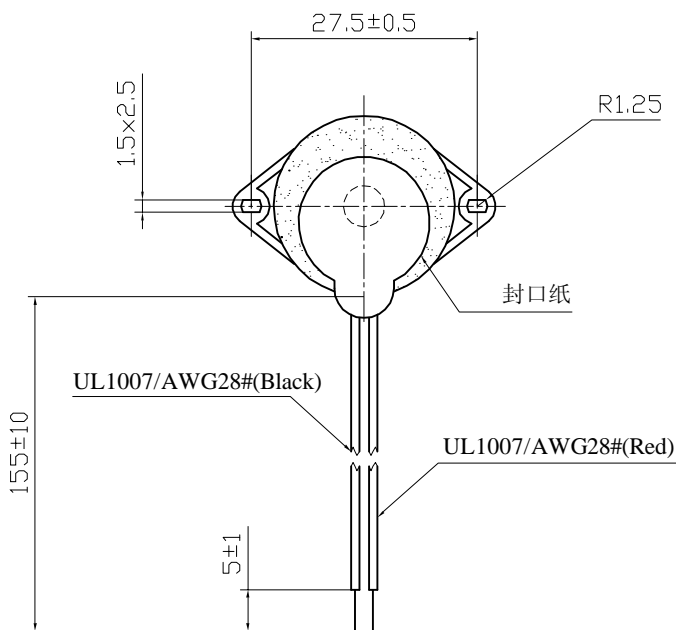
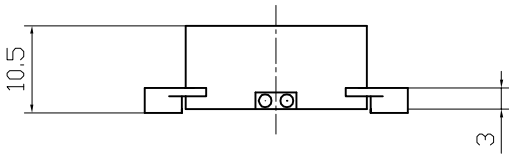
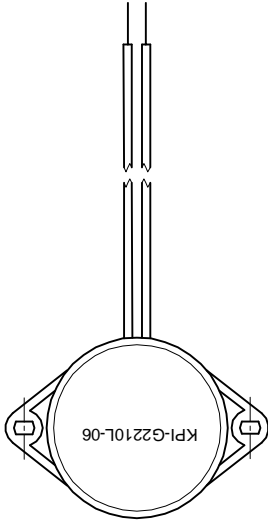

FIRST ANGLE PROJECTION

UNIT : mm
Tolerance : ±0.5

Specification for Buzzer	Page	7/8
	Revision No.	1.0
	Drawing No.	OEM9891R
Model No. : KPI-G2210L-06-K9891		

9. 包装标准 Packaging Standard

产品的外包装是纸箱,它应该清楚的标明型号,数量,出厂检验批号.
在运输及储存的过程中,产品必须不会受到机械损伤.

Each minimum package unit of products shall be in a carton box and it shall be clearly marked with Part Number, quantity and outgoing inspection number.

There shall be no mechanical damage on products during transportation and/or in storage.

10. 警告 Cautions

如果产品使用于下列高可靠性的装置时,请与我们联系,以免对人的生命,财产和身体造成损害.

Please contact us before using our products for the undermentioned applications requiring especially high reliability in order to prevent defects which might directly cause damage to other party's life, body or property (listed below).

- (1) Aircraft equipment 飞行设备
- (2) Aerospace equipment 航天设备
- (3) Undersea equipment 潜水设备
- (4) Medical equipment 医疗设备
- (5) Transportation equipment (automobiles, trains, ships) 交通设施
- (6) Traffic signal equipment 交通信号设备
- (7) Disaster prevention/crime prevention equipment 防灾害/防犯罪设备
- (8) Data-processing equipment 数据处理设备
- (9) Applications of similar complexity or reliability requirements comparable to the applications listed in the above 以及与上述相类似或可靠性要求更高的设备

11. 注意事项 Cautions for Use

- 11.1 如果产品所承受的机械应力超过规定的值,元件可能被破坏.

The component may be damaged if mechanical stress over this specification is applied.

- 11.2 请注意保护工作电路不会因失误,跌落和温度变化而产生浪涌电压.

Please pay attention to protect operating circuit from surge voltage provided by something of force such as failing, shock and temperature changing.

- 11.3 请注意永远不要给压电声响器施加直流电压.

Please pay attention never to be applied DC voltage to piezo sounder.

- 11.4 该声响器不适合洗涤,因为它不密封.

Washing of the component is not acceptable. Because it is not sealed.

- 11.5 在使用烙铁的情况下,应注意烙铁头的温度应该保持在 +350℃ 以下,并且焊接时间控制在3秒内.

In case of using solder iron for soldering, the top of soldering iron's temperature should be kept less than +350 °C. Moreover the soldering time should be also kept with in 3seconds.

Specification for Buzzer	Page	8/8
	Revision No.	1.0
	Drawing No.	OEM9891R

Model No. : KPI-G2210L-06-K9891

12. Revision

Rev. No.	DATE	PAGE	DESCRIPTION	SIGN
1.0	2013.9.29	/	primary	